

Complementarios















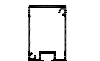

2 Indice de Perfiles**Detalle de Perfiles en Escala 1:1**



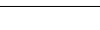
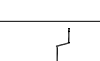
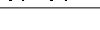
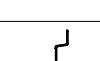

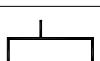

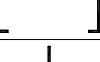
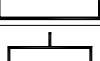
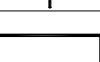
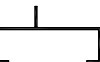











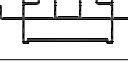



- 6 Baranda BBA
- 7 Baranda Clásica
- 8 Perfiles para Blindex
- 9 Mampara de Baño 900
- 10 Frente de Placard
- 11 Tabiquería Alcemar
- 12 Perfiles para Techo
- 13 Ángulos Normalizados
- 14 Tubos Normalizados / Planchuela / Canales Lisos y Aletados /
Tubos Aletados
- 19 Aireador / Escuadras Universales























Peso de las Barras de Perfiles: El peso por metro de los perfiles es estimado, con una tolerancia de + / - 10%.

Largo de las Barras de Perfiles: La medida Standard de las Barras de Perfiles es de 6.030 milímetros, salvo aclaración en contrario.

Alsafex S.A. se reserva el derecho de realizar cambios y/o modificaciones sin previo aviso de los artículos indicados en el presente Catálogo.

CODIGO	PESO (Kg/m.)	LARGO (mm.)	DESCRIPCION	FORMA	PAG.
1080791	0,44	6.030	Prensa Techo		12
1080792	0,37	6.030	Tapa Techo		12
1090028	1,35	6.030	Pasamanos Curvo Baranda BBA		6
1090029	0,20	6.030	Tapa Inferior Pasamanos Baranda BBA		6
1090030	0,83	6.030	Parante Baranda BBA		6
0190031	0,38	6.030	Porta Blisan Inferior Baranda BBA		6
1090044	0,31	6.020	Travesaño de Hoja Mampara de Baño 900		9
1090049	0,19	6.020	Tubo Cuadrado 15 x 15 mm.		15
1090050	0,13	6.020	Planchuela 15,9 x 3 mm.		15
1090055	0,56	6.030	Escuadra Universal Intermedia		19
1090056	0,14	6.020	Planchuela 25,4 x 2 mm.		15
1090063	0,74	6.030	Escuadra Universal Pesada		19
1090110	1,66	6.030	Zócalo Puerta Blindex		8
1090111	0,39	6.030	Suplemento Zócalo Blindex		8
1090112	0,90	6.030	Tubo con Un Ala 75 x 25 mm.		16
1090113	0,97	6.030	Tubo con Dos Alas 75 x 25 mm.		16
1090114	0,98	6.030	Canal Liso 90 x 40 mm.		17
1090115	1,06	6.030	Canal con Un Ala 90 x 40 mm.		17
1090116	1,44	6.030	Tubo con Un Ala 90 x 40 mm.		18
1090117	1,52	6.030	Tubo con Dos Alas 90 x 40 mm.		18
1090118	0,60	6.030	Canal Liso 75 x 25 mm.		16
1090119	0,66	6.030	Canal con Un Ala 75 x 25 mm.		16
1090124	0,64	6.030	Angulo 100 x 20 mm.		13

CODIGO	PESO (Kg/m.)	LARGO (mm.)	DESCRIPCION	FORMA	PAG.
1090125	0,29	6.030	Angulo 60 x 12 mm.		13
1090155	0,53	5.200	Parante de 15 mm. Frente de Placard		10
1090156	0,16	6.030	Cantonera de 15 mm. Frente de Placard		10
1090157	0,25	6.030	Guía Inferior Frente de Placard		10
1090158	0,20	6.030	Cantonera de 18 mm. Frente de Placard		10
1090159	0,54	5.200	Parante de 18 mm. Frente de Placard		10
1090160	0,68	6.030	Guía Superior Frente de Placard		10
1090191	1,19	6.030	Larguero de Techo		12
1090192	1,27	6.030	Travesaño de Techo		12
1090355	0,55	6.030	Marco Aireador Aletado Con Mosquitero		19
1090439	1,05	6.030	Pasamanos Recto Baranda Clásica		7
1090457	0,90	6.030	Tubo Rectangular 75 x 25 mm.		16
1090458	1,23	6.030	Tubo Rectangular 90 x 40 mm.		17
1090464	1,12	6.030	Tubo Rectangular de 75 x 50 mm.		14
1090468	0,53	6.030	Porta Vidrio Baranda Clásica		7
1090475	1,30	6.030	Pasamanos Redondo Baranda Clásica		7
1090476	0,61	6.030	Parante Baranda Clásica		7
1090477	0,56	6.030	Base de Pasamanos Baranda Clásica		7
1090478	0,51	6.030	Parante Angosto Baranda Clásica		7
1090490	0,67	6.030	Columna Tabiquería Alcemar		11
1090491	0,40	6.030	Tapa Columna Tabiquería Alcemar		11
1090492	0,54	6.030	Travesaño Tabiquería Alcemar		11
1090493	0,48	6.030	Marco Tabiquería Alcemar		11

CODIGO	PESO (Kg/m.)	LARGO (mm.)	DESCRIPCION	FORMA	PAG.
1090494	0,19	6.030	Tapa Terminación Tabiquería Alcemar		11
1090498	0,34	6.030	Tapa Zócalo Tabiquería Alcemar		11
1090499	1,04	6.030	Zócalo Tabiquería Alcemar		11
1090585	0,25	6.020	Tubo Cuadrado 20 x 20 mm.		15
1090587	0,15	6.020	Tubo Cuadrado 12,7 x 12,7 mm.		17
1090588	0,15	6.020	Planchuela 19 x 3 mm.		15
1090650	0,25	6.030	"U" de Blindex		8
1090751	0,08	6.030	Angulo 12,7 x 12,7 mm.		13
1090752	0,10	6.030	Angulo 15 x 15 mm.		13
1090753	0,14	6.030	Angulo 19 x 19 mm.		13
1090755	0,16	6.030	Angulo 25,4 x 25,4 mm.		13
1090756	0,34	6.030	Angulo 32 x 32 mm.		13
1090757	0,34	6.030	Angulo 38 x 38 mm.		13
1090758	0,30	6.030	Angulo 50 x 25 mm.		13
1090759	0,79	6.030	Angulo 50 x 50 mm.		13
1090804	0,36	6.030	Tubo Cuadrado 25 x 25 mm.		15
1090805	0,46	6.030	Tubo Rectangular 40 x 20 mm.		14
1090806	0,40	6.030	Tubo Cuadrado 30 x 30 mm.		15
1090807	0,63	6.030	Tubo Cuadrado 38 x 38 mm.		15
1090808	0,71	6.030	Tubo Cuadrado 45 x 45 mm.		15
1090809	0,55	6.030	Tubo Rectangular 50 x 25 mm.		14
1090810	0,32	6.030	Tubo Rectangular 30 x 12 mm.		14
1090811	0,79	6.030	Tubo Cuadrado 50 x 50 mm.		15

CODIGO	PESO (Kg/m.)	LARGO (mm.)	DESCRIPCION	FORMA	PAG.
1090812	0,63	6.030	Tubo Rectangular 60 x 20 mm.		14
1090813	0,68	6.030	Tubo Rectangular 60 x 30 mm.		14
1090830	0,16	6.030	Perfil "T" 25 x 25 mm.		13
1090941	0,82	6.030	Cabezal Mampara de Baño 900		9
1090942	0,37	6.030	Umbral Mampara de Baño 900		9
1090943	0,32	6.030	Jamba Mampara de Baño 900		9
1090944	0,35	6.030	Hoja Mampara de Baño 900		9
1090946	0,24	6.030	Barra Toallera		9
1090970	2,00	6.030	Tubo Rectangular 110 x 54 mm.		14
1090995	0,31	6.030	Caño Redondo 25,4 mm.		15
1090996	0,47	6.030	Caño Redondo 38,1 mm.		15
1090997	0,63	6.030	Caño Redondo de 50,8 mm.		8

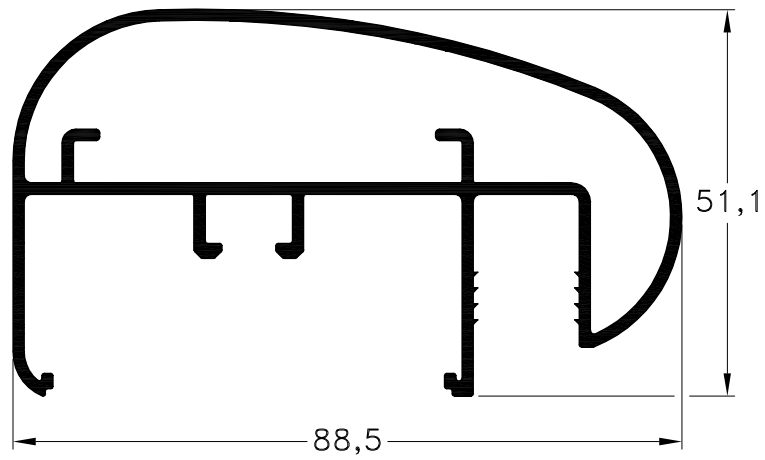

1090028 - Pasamanos Curvo
 Peso: 1,35 Kg/m.
 Largo Std.: 6.030 mm.

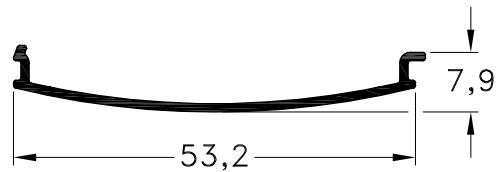

1090029 - Tapa Inferior Pasamanos Curvo
 Peso: 0,20 Kg/m.
 Largo Std.: 6.030 mm.

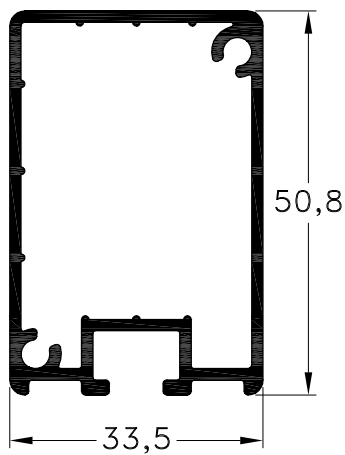

1090030 - Parante
 Peso: 0,83 Kg/m.
 Largo Std.: 6.030 mm.

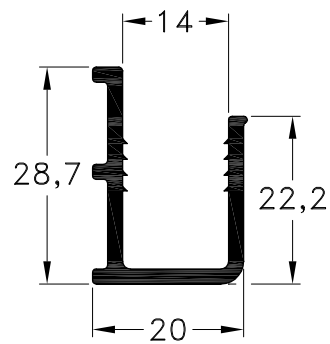

1090031 - Porta Blisan Inferior
 Peso: 0,38 Kg/m.
 Largo Std.: 6.030 mm.

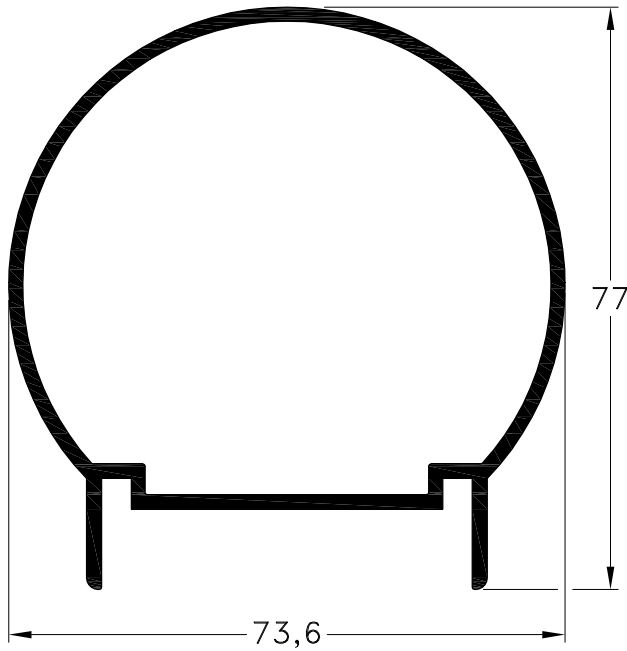

1090475 - Pasamanos
Peso: 1,30 Kg/m.
Largo Std.: 6.030 mm.

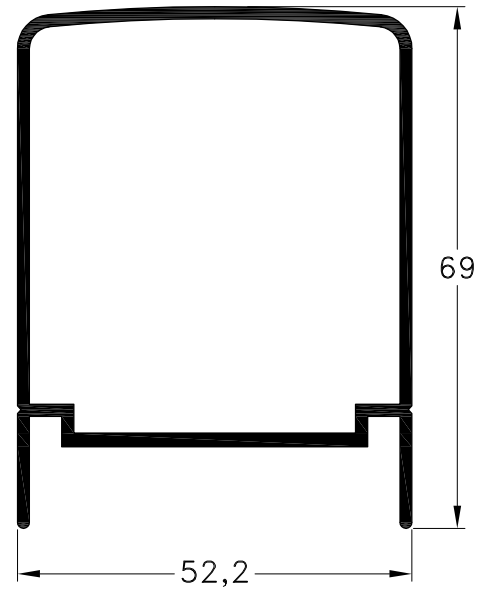

1090439 - Pasamanos
Peso: 1,05 Kg/m.
Largo Std.: 6.030 mm.

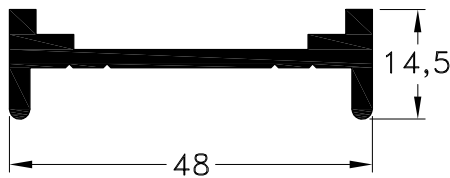

1090477 - Base de Pasamanos
Peso: 0,56 Kg/m.
Largo Std.: 6.030 mm.

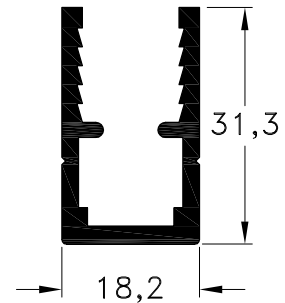

1090468 - Porta Vidrio
Peso: 0,53 Kg/m.
Largo Std.: 6.030 mm.

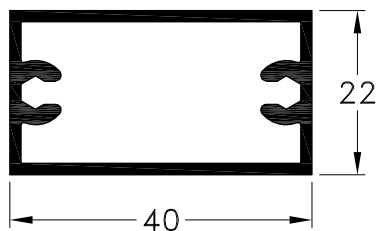

1090476 - Parante
Peso: 0,61 Kg/m.
Largo Std.: 6.030 mm.

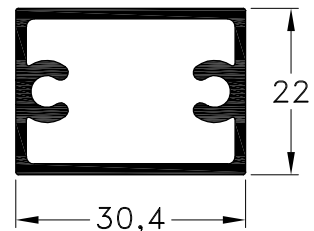

1090478 - Parante Angosto
Peso: 0,51 Kg/m.
Largo Std.: 6.030 mm.

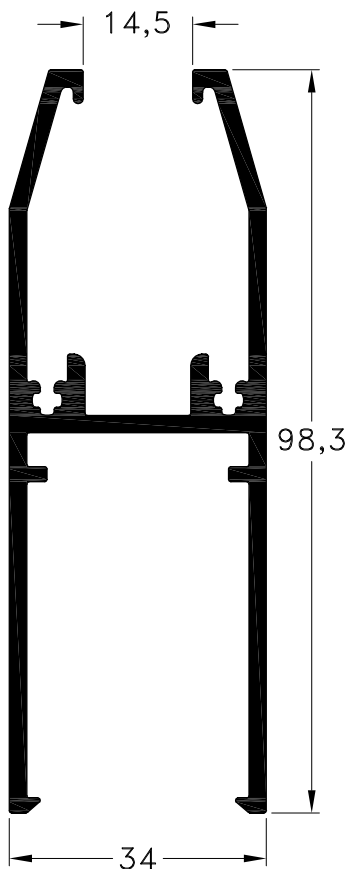

1090110 - Zócalo
 Peso: 1,66 Kg/m.
 Largo Std.: 6.030 mm.

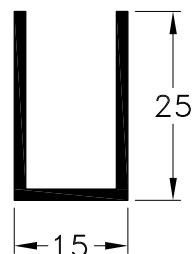

1090650 - "U" de Blindex
 Peso: 0,25 Kg/m.
 Largo Std.: 6.030 mm.

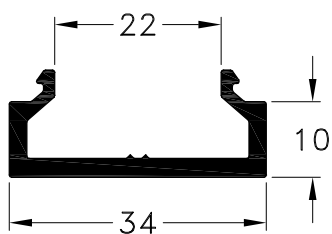

1090111 - Suplemento Zócalo
 Peso: 0,39 Kg/m.
 Largo Std.: 6.030 mm.

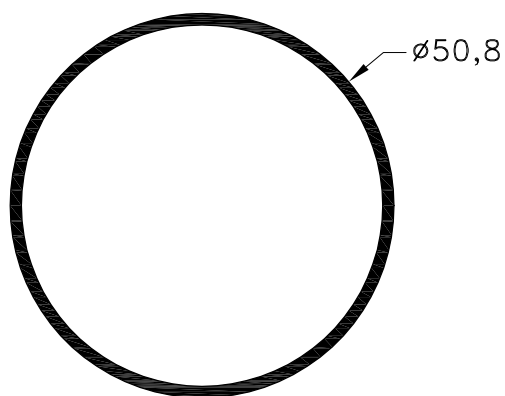

1090997 - Caño Redondo
 Peso: 0,63 Kg/m.
 Largo Std.: 6.030 mm.

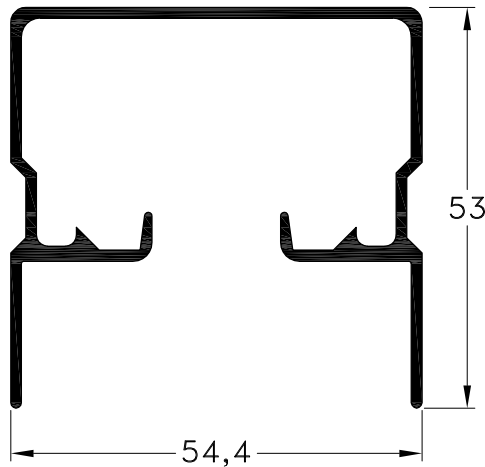

1090941 - Cabezal
Peso: 0,82 Kg/m.
Largo Std.: 6.030 mm.

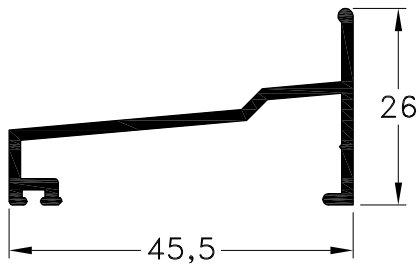

1090942 - Umbral
Peso: 0,37 Kg/m.
Largo Std.: 6.030 mm.

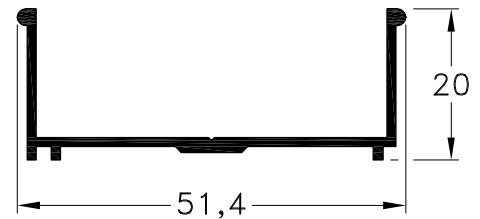

1090943 - Jamba
Peso: 0,32 Kg/m.
Largo Std.: 6.030 mm.

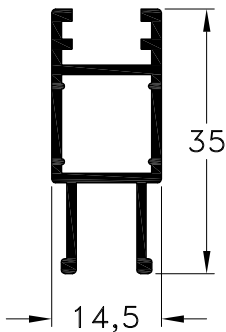

1090944 - Hoja
Peso: 0,35 Kg/m.
Largo Std.: 6.030 mm.

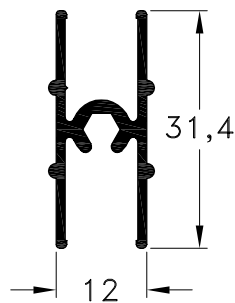

1090044 - Travesaño de Hoja
Peso: 0,31 Kg/m.
Largo Std.: 6.020 mm.

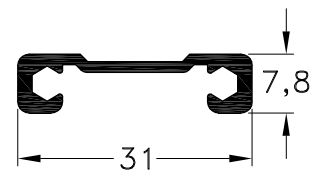

1090946 - Barra Toallera
Peso: 0,24 Kg/m.
Largo Std.: 6.030 mm.

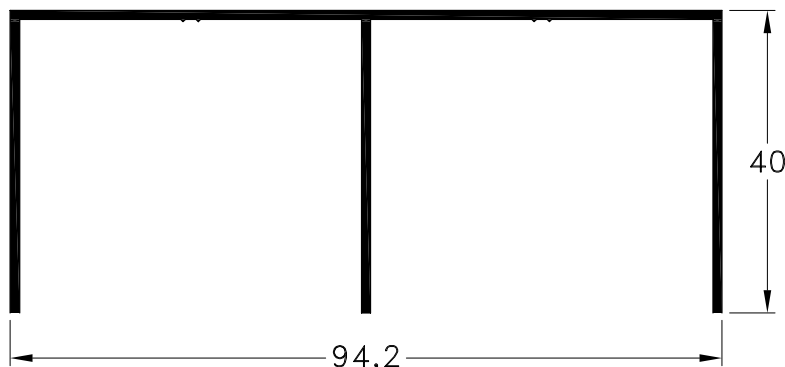

1090160 - Guía Superior
 Peso: 0,68 Kg/m.
 Largo Std.: 6.030 mm.

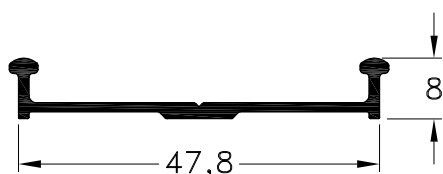

1090157 - Guía Inferior
 Peso: 0,25 Kg/m.
 Largo Std.: 6.030 mm.

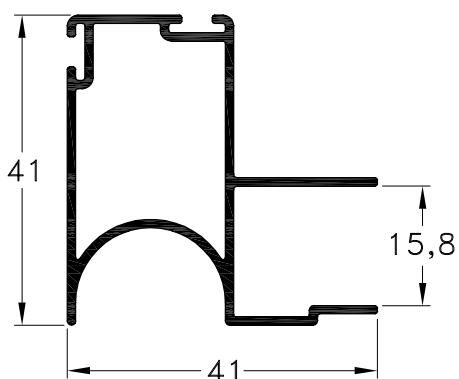

1090155 - Parante de 15 mm.
 Peso: 0,53 Kg/m.
 Largo Std.: 5.200 mm.

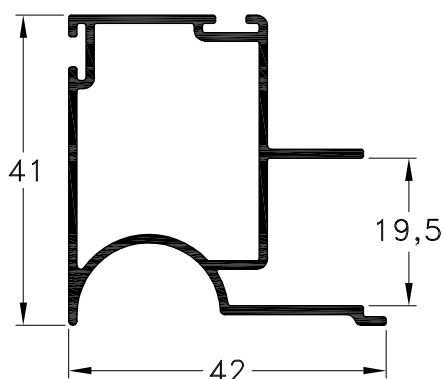

1090159 - Parante de 18 mm.
 Peso: 0,54 Kg/m.
 Largo Std.: 5.200 mm.

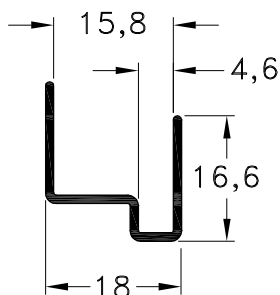

1090156 - Cantonera de 15 mm.
 Peso: 0,16 Kg/m.
 Largo Std.: 6.030 mm.

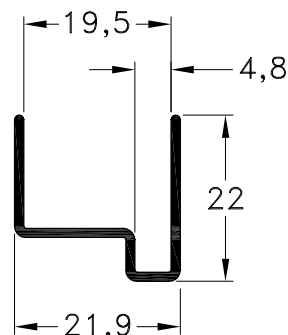

1090158 - Cantonera de 18 mm.
 Peso: 0,20 Kg/m.
 Largo Std.: 6.030 mm.

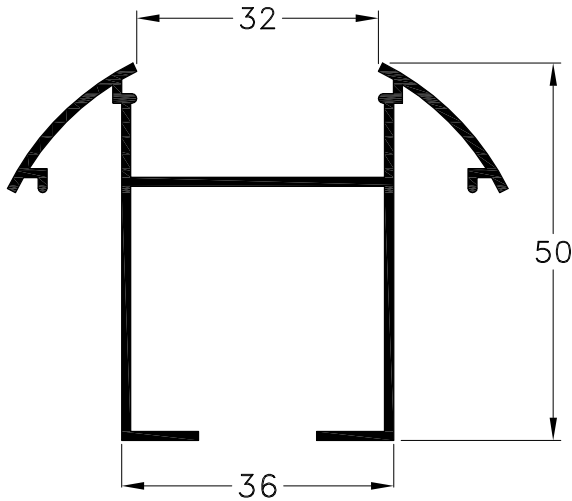

1090490 - Columna
Peso: 0,67 Kg/m.
Largo Std.: 6.030 mm.

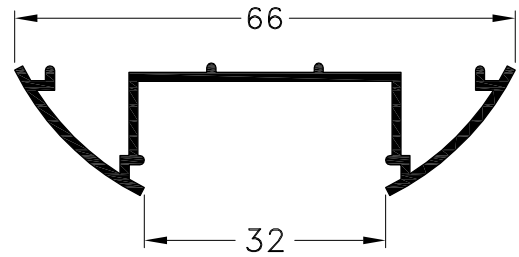

1090491 - Tapa Columna
Peso: 0,40 Kg/m.
Largo Std.: 6.030 mm.

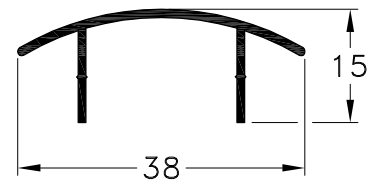

1090494 - Tapa
Peso: 0,19 Kg/m.
Largo Std.: 6.030 mm.

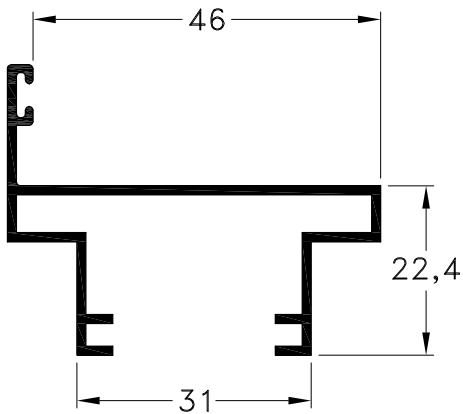

1090493 - Marco
Peso: 0,48 Kg/m.
Largo Std.: 6.030 mm.

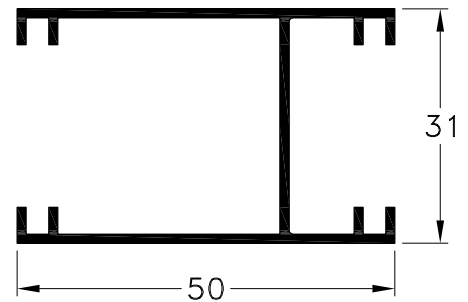

1090492 - Travesaño
Peso: 0,54 Kg/m.
Largo Std.: 6.030 mm.

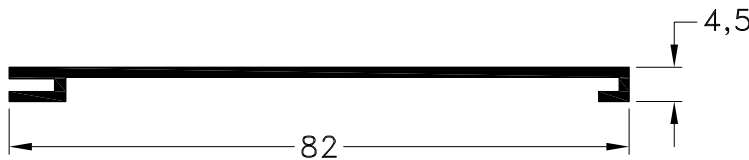

1090498 - Tapa Zócalo
Peso: 0,34 Kg/m.
Largo Std.: 6.030 mm.

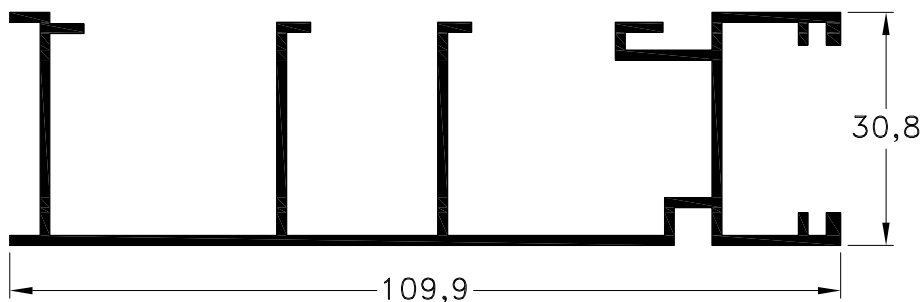

1090499 - Zócalo
Peso: 1,04 Kg/m.
Largo Std.: 6.030 mm.

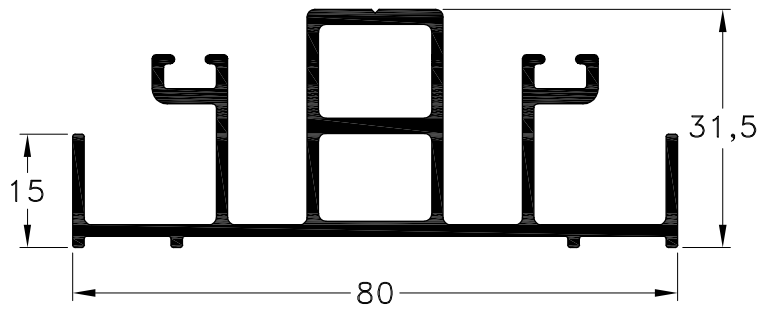

1090191 - Larguero
 Peso: 1,19 Kg/m.
 Largo Std.: 6.030 mm.

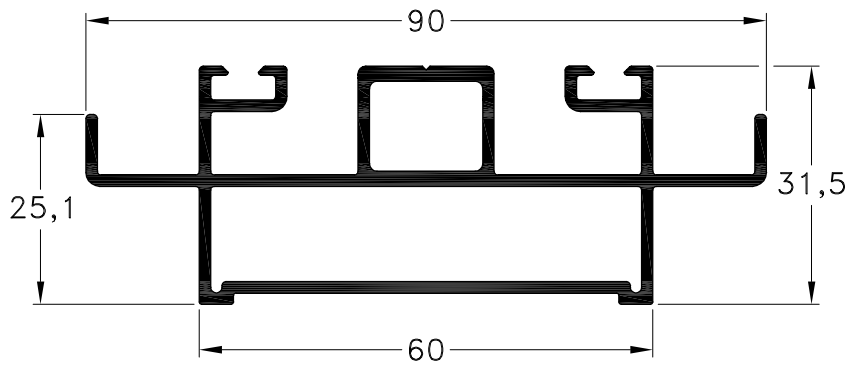

1090192 - Travesaño
 Peso: 1,27 Kg/m.
 Largo Std.: 6.030 mm.

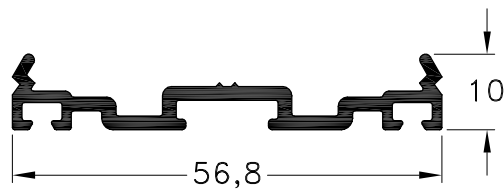

1080791 - Prensa
 Peso: 0,44 Kg/m.
 Largo Std.: 6.030 mm.

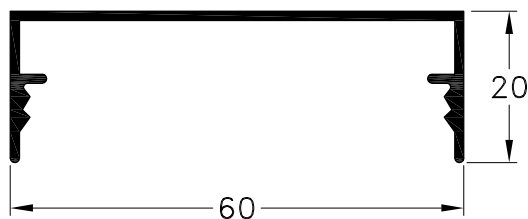

1080792 - Tapa
 Peso: 0,37 Kg/m.
 Largo Std.: 6.030 mm.

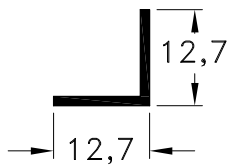

1090751 - Perfil Angulo
 Peso: 0,08 Kg/m.
 Largo Std.: 6.030 mm.

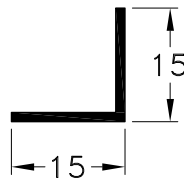

1090752 - Perfil Angulo
 Peso: 0,10 Kg/m.
 Largo Std.: 6.030 mm.

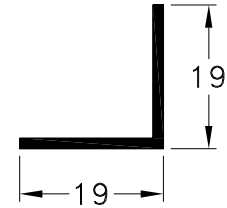

1090753 - Perfil Angulo
 Peso: 0,14 Kg/m.
 Largo Std.: 6.030 mm.

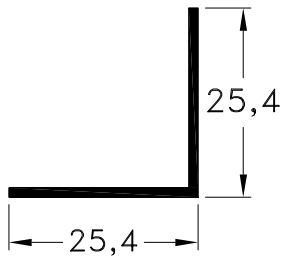

1090755 - Perfil Angulo
 Peso: 0,16 Kg/m.
 Largo Std.: 6.030 mm.

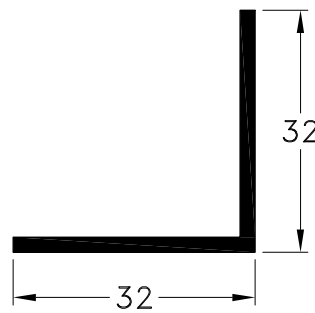

1090756 - Perfil Angulo
 Peso: 0,34 Kg/m.
 Largo Std.: 6.030 mm.

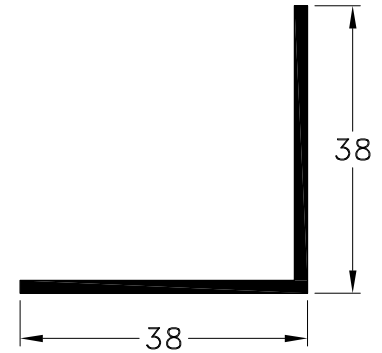

1090757 - Perfil Angulo
 Peso: 0,34 Kg/m.
 Largo Std.: 6.030 mm.

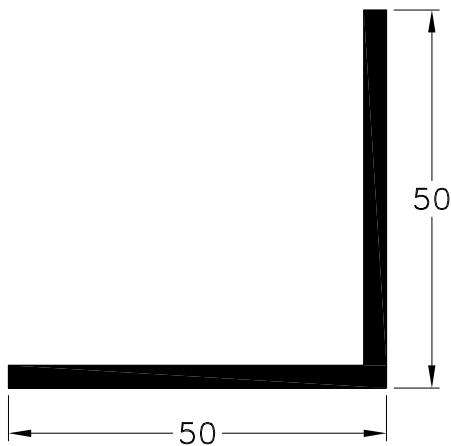

1090759 - Perfil Angulo
 Peso: 0,79 Kg/m.
 Largo Std.: 6.030 mm.

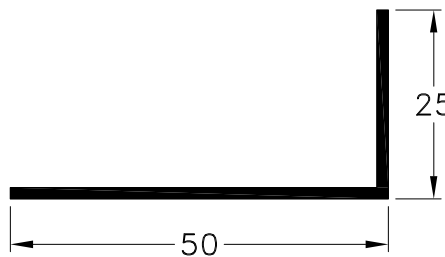

1090758 - Perfil Angulo
 Peso: 0,30 Kg/m.
 Largo Std.: 6.030 mm.

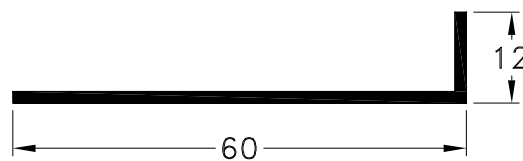

1090125 - Perfil Angulo
 Peso: 0,29 Kg/m.
 Largo Std.: 6.030 mm.

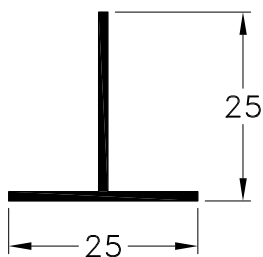

1090830 - Perfil T
 Peso: 0,16 Kg/m.
 Largo Std.: 6.030 mm.

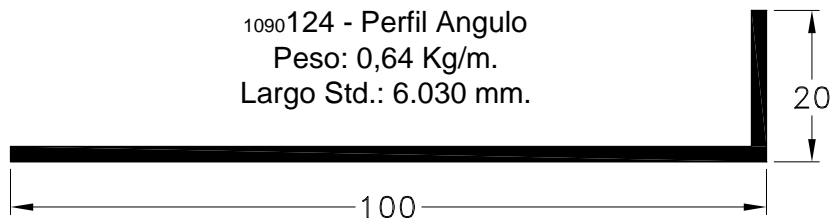

1090124 - Perfil Angulo
 Peso: 0,64 Kg/m.
 Largo Std.: 6.030 mm.

Perfil	Espesor	Perfil	Espesor	Perfil	Espesor
1090124	2 mm.	1090753	1,4 mm.	1090758	1,5 mm.
1090125	1,5 mm.	1090755	1,2 mm.	1090759	3 mm.
1090751	1,2 mm.	1090756	2 mm.	1090830	1,2 mm.
1090752	1,2 mm.	1090757	1,7 mm.		

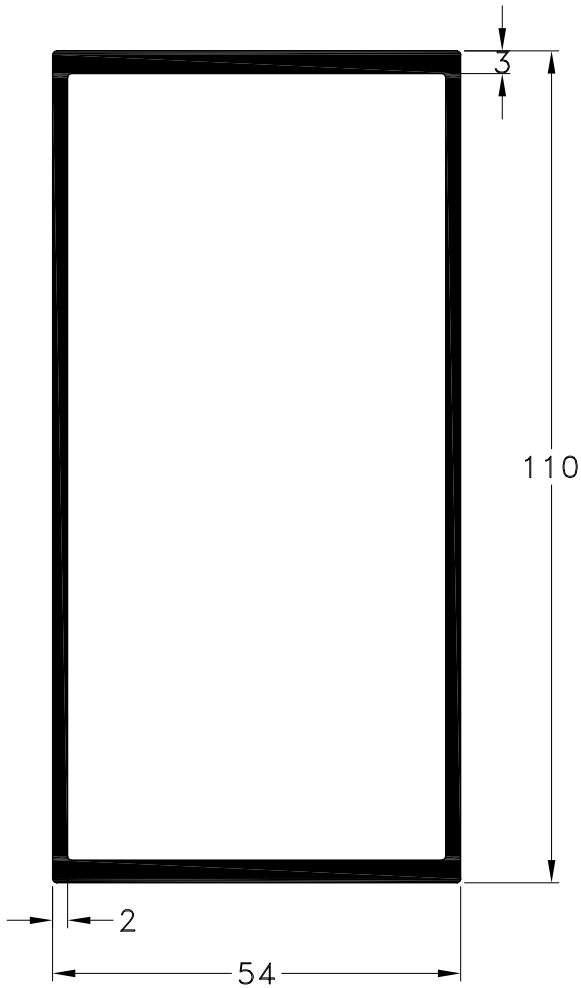

1090970 - Tubo 110 x 54 mm.
Peso: 2,00 Kg/m.
Largo Std.: 6.030 mm.

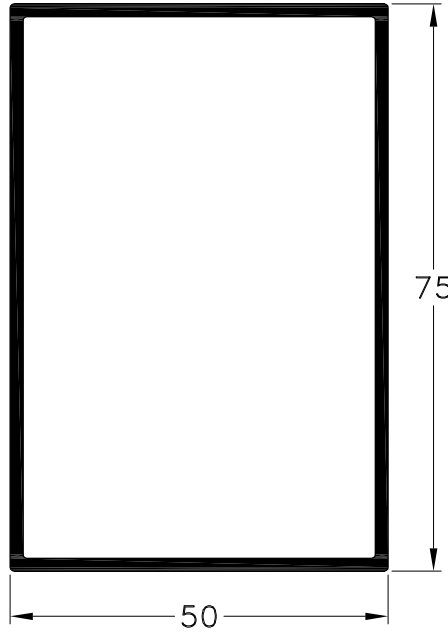

1090464 - Tubo 75 x 50 mm.
Peso: 1,12 Kg/m.
Largo Std.: 6.030 mm.

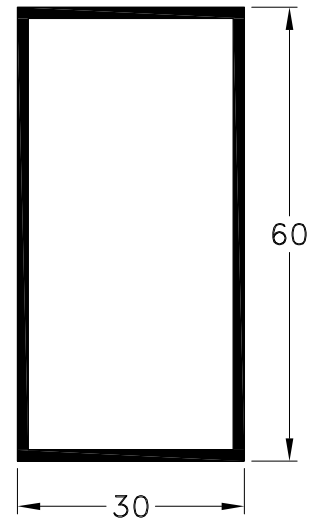

1090813 - Tubo 60 x 30 mm.
Peso: 0,68 Kg/m.
Largo Std.: 6.030 mm.

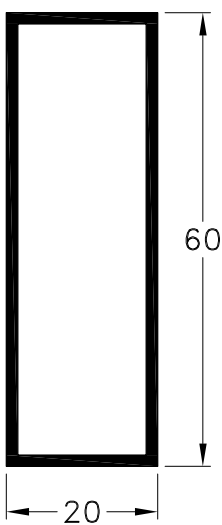

1090812 - Tubo
60 x 20 mm.
Peso: 0,63 Kg/m.
Largo Std.: 6.030 mm.

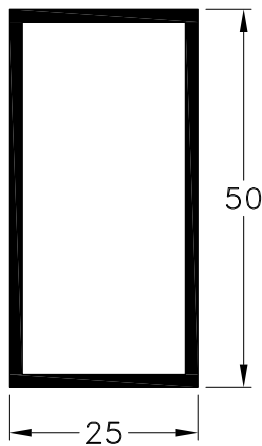

1090809 - Tubo
50 x 25 mm.
Peso: 0,55 Kg/m.
Largo Std.: 6.030 mm.

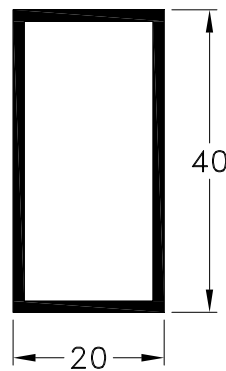

1090805 - Tubo
40 x 20 mm.
Peso: 0,46 Kg/m.
Largo Std.: 6.030 mm.

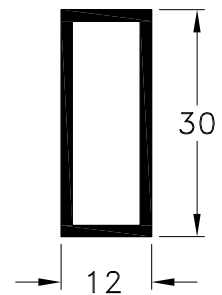

1090810 - Tubo
30 x 12 mm.
Peso: 0,32 Kg/m.
Largo Std.: 6.030 mm.

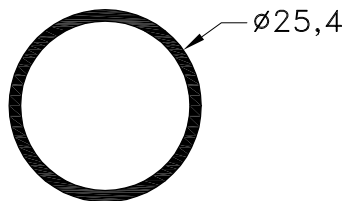
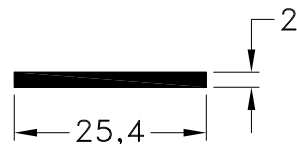
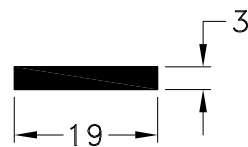
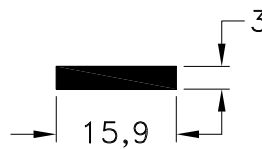
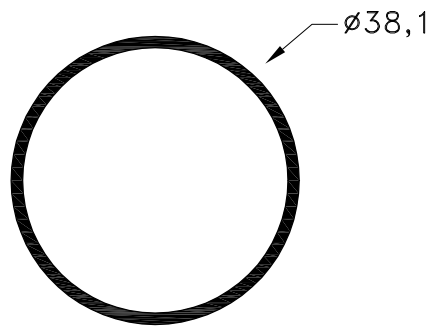
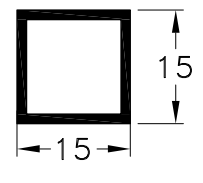
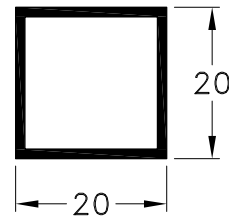
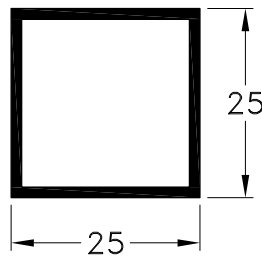
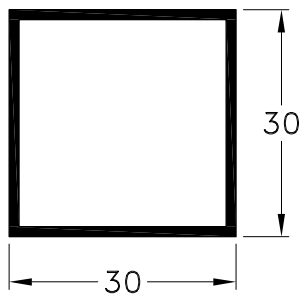
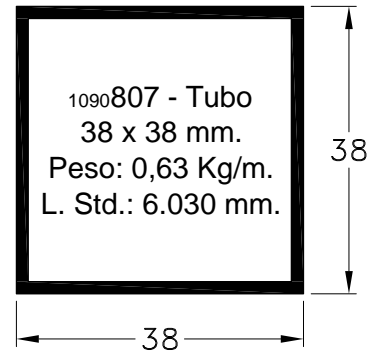
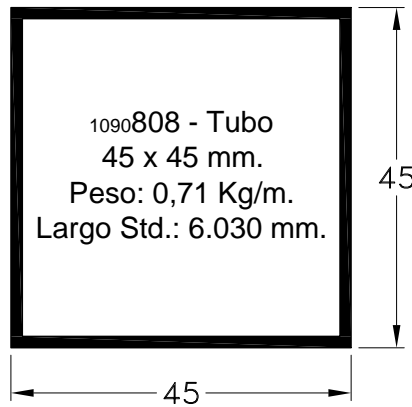
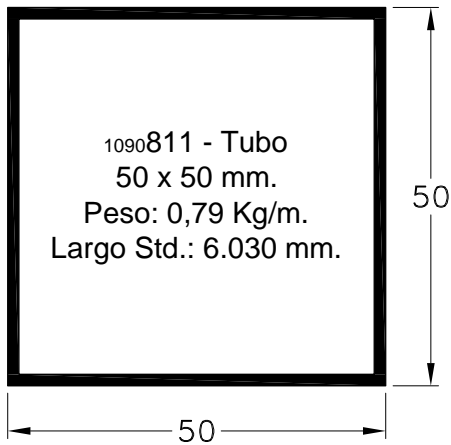

Perfil	Espesor	Perfil	Espesor	Perfil	Espesor
1090049	1,25 mm.	1090806	1,3 mm.	1090812	1,5 mm.
1090457	1,7 mm.	1090807	1,6 mm.	1090813	1,5 mm.
1090458	1,8 mm.	1090808	1,5 mm.	1090995	1,5 mm.
1090464	1,7 mm.	1090809	1,5 mm.	1090996	1,5 mm.
1090804	1,4 mm.	1090810	1,5 mm.	1090020	1,25 mm.
1090805	1,5 mm.	1090811	1,5 mm.	1090101	1,25 mm.

Escala 1:1

Tolerancia en Peso +/- 10%

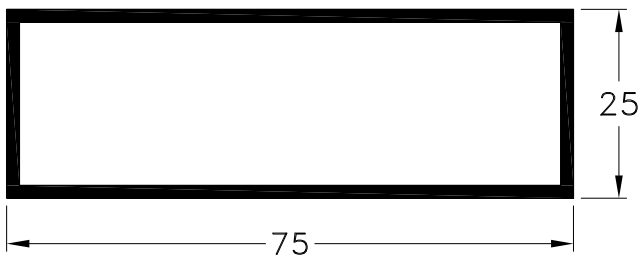

1090457 - Tubo 75 x 25 mm.
Peso: 0,90 Kg/m.
Largo Std.: 6.030 mm.

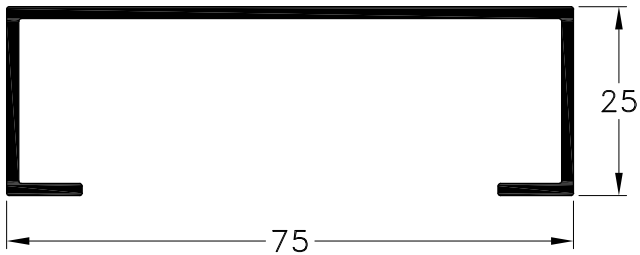

1090118 - Canal Liso 75 x 25 mm.
Peso: 0,60 Kg/m.
Largo Std.: 6.030 mm.

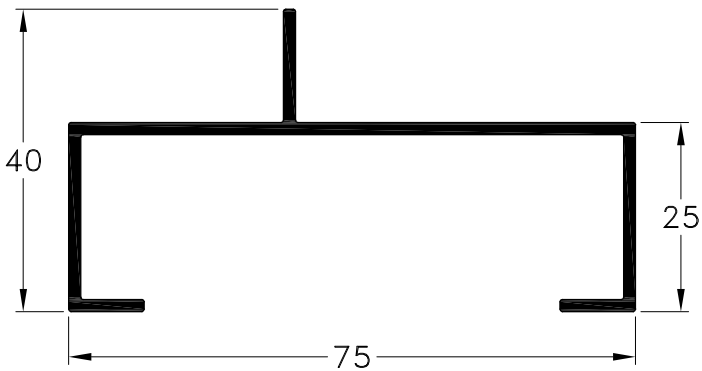

1090119 - Canal con Un Ala 75 x 25 mm.
Peso: 0,66 Kg/m.
Largo Std.: 6.030 mm.

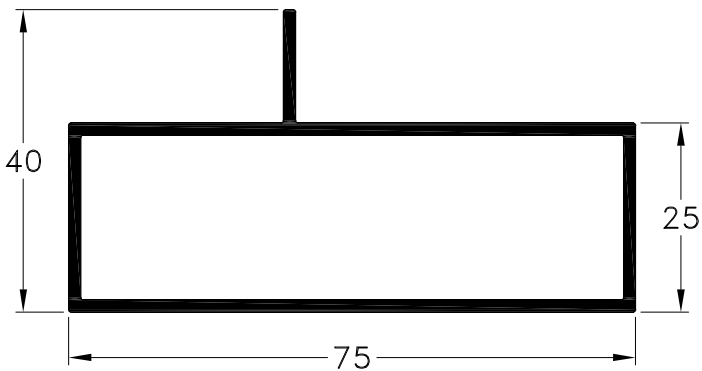

1090112 - Tubo con Un Ala 75 x 25 mm.
Peso: 0,90 Kg/m.
Largo Std.: 6.030 mm.

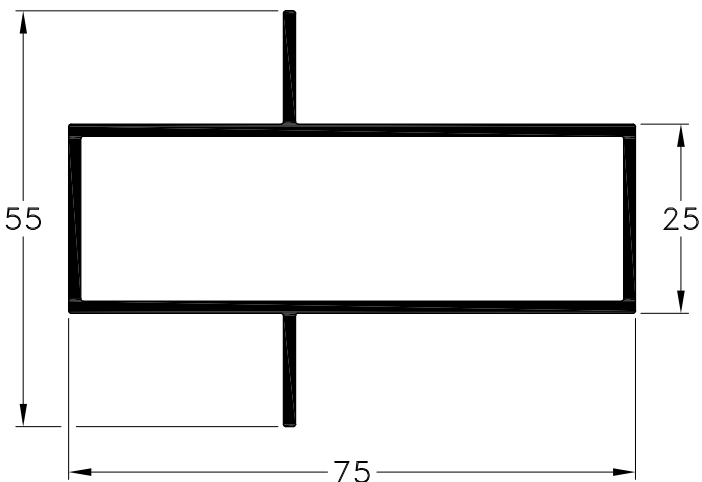

1090113 - Tubo con Dos Alas 75 x 25 mm.
Peso: 0,97 Kg/m.
Largo Std.: 6.030 mm.

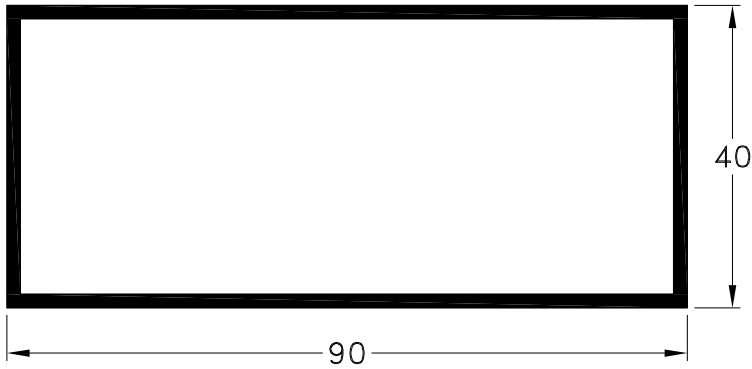

1090458 - Tubo 90 x 40 mm.
Peso: 1,23 Kg/m.
Largo Std.: 6.030 mm.

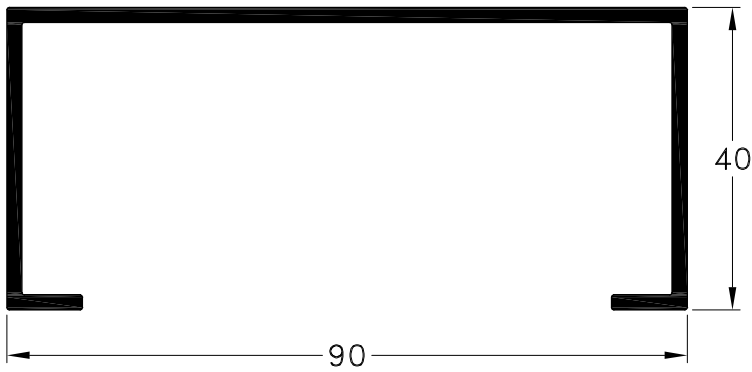

1090114 - Canal Liso 90 x 40 mm.
Peso: 0,98 Kg/m.
Largo Std.: 6.030 mm.

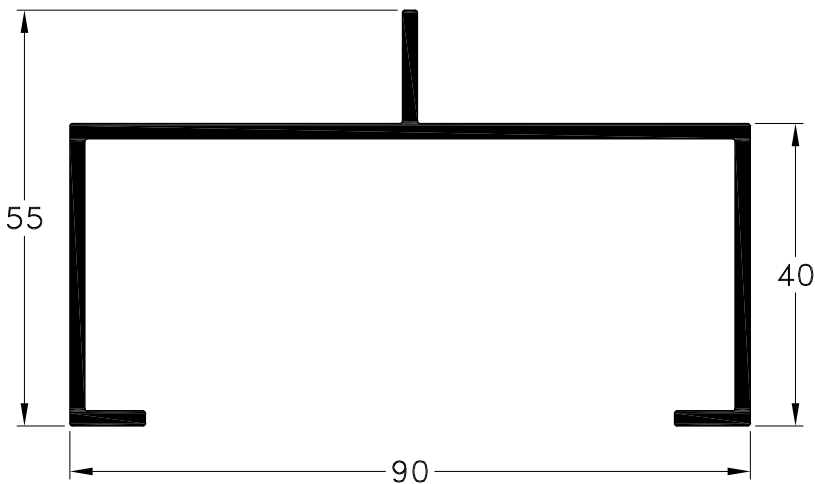

1090115 - Canal con Un Ala 90 x 40 mm.
Peso: 1,06 Kg/m.
Largo Std.: 6.030 mm.

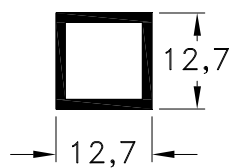

1090587 - Tubo 12,7 x 12,7 mm.
Peso: 0,15 Kg/m.
Largo Std.: 6.020 mm.

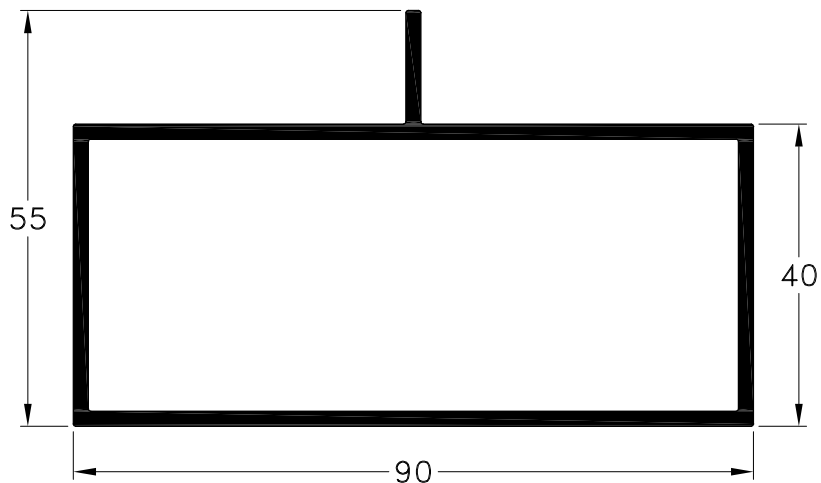

1090116 - Tubo con Un Ala 90 x 40 mm.
Peso: 1,44 Kg/m.
Largo Std.: 6.030 mm.

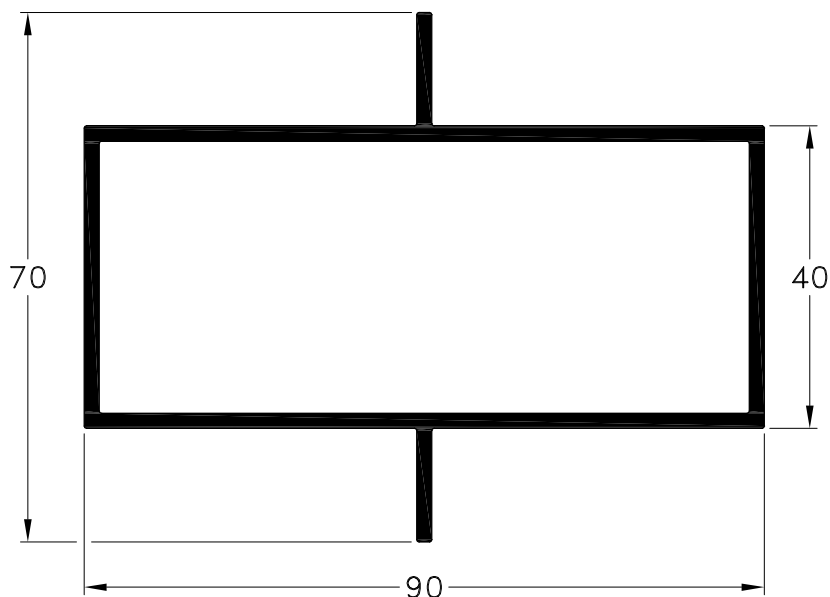

1090117 - Tubo con Dos Alas 90 x 40 mm.
Peso: 1,52 Kg/m.
Largo Std.: 6.030 mm.

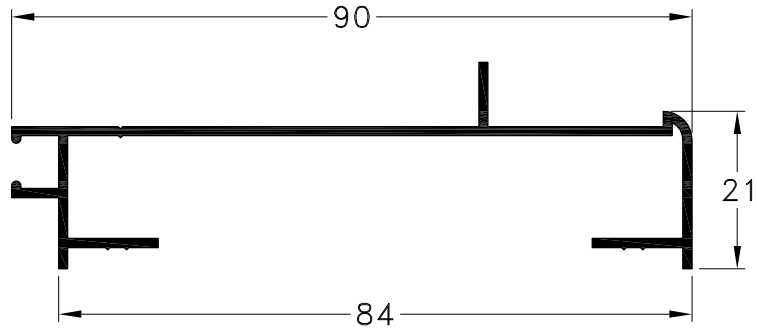

1090355 - Marco Aireador
Aletado con Mosquitero
Peso: 0,55 Kg/m.
Largo Std.: 6.030 mm.

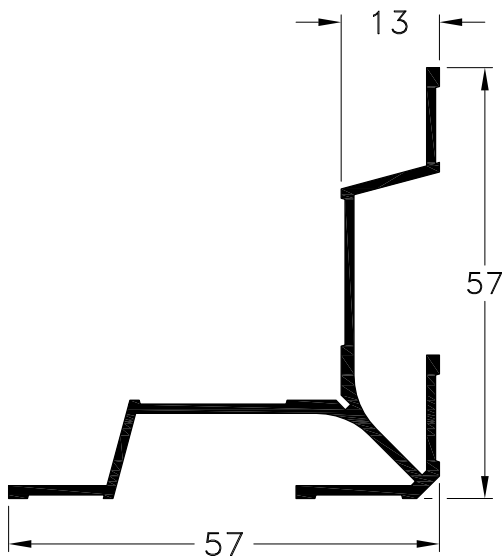

1090055 - Escuadra Universal Intermedia
Peso: 0,56 Kg/m.
Largo Std.: 6.030 mm.

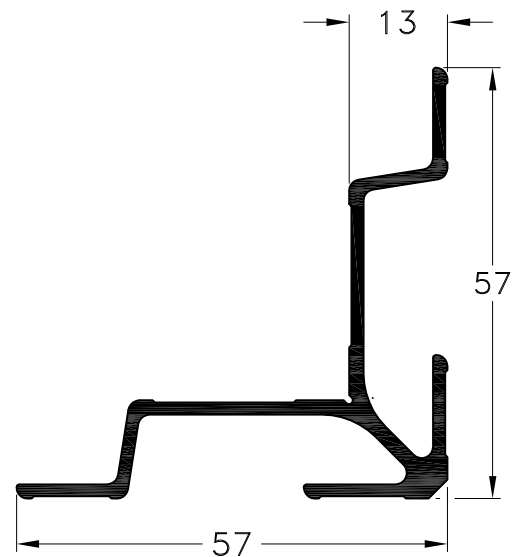

1090063 - Escuadra Universal Pesada
Peso: 0,74 Kg/m.
Largo Std.: 6.030 mm.

